

ALUTRUSS TRILOCK S-PAC 20 2-Way Corner 60° black

3-point truss system

Art. No.: 6030253G

GTIN: 4026397559712

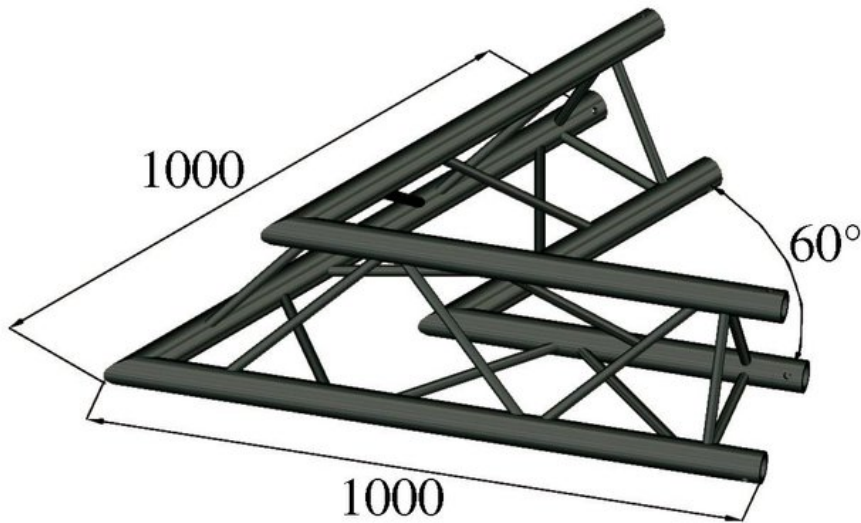

List price: 398.65 €

incl. 19% VAT.

Features:

- Low weight
- Easy installation
- Trusspipe: 50 mm
- Made in Europe
- For application areas such as: Theater; Trade fair and shop fitting; Clubs/dancing school

Logistic

EAN / GTIN: 4026397559712

Weight: 6,30 kg

Length: 1.00 m

Width: 0.98 m

Height: 0.26 m

Bulky product

Technical specifications:

Setup: Easy installation

Trusspipe: 50 mm x 2 mm

Color: Black

Strut diameter x thickness: 16 x 2mm

Dimensions: Length: 1 m
Width: 1 m
Height: 25,70 cm

Weight: 5,8 kg