

ALUTRUSS BILOCK BQ2-SPAT42V 4-Way T-Piece bk

2-point truss system

Art. No.: 60210364

GTIN: 4026397669787

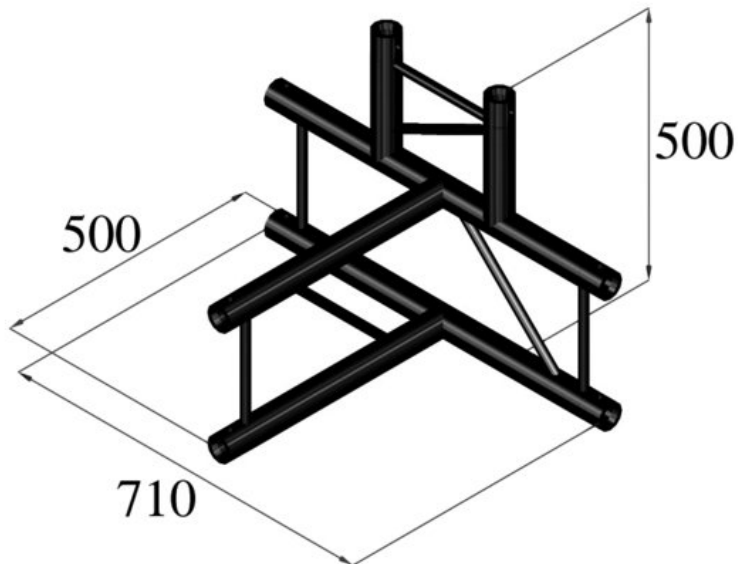

List price: 279.65 €

incl. 19% VAT.

Features:

- High-quality aluminum-tubes with 50 mm in diameter
- Low weight
- Easy installation
- Direction Vertical
- Trusspipe: 50 mm
- Made in Europe
- For application areas such as: Theater; Trade fair and shop fitting; Clubs/dancing school

Package contents

- 1 x connection Set

Logistic

EAN / GTIN: 4026397669787

Weight: 5,90 kg

Length: 0.72 m

Width: 0.54 m

Height: 0.50 m

Technical specifications:

Setup:	Easy installation
Trusspipe:	50 mm x 2 mm
Welding technique:	TIG-welding
Welding material:	AlMg 5
Color:	Black, matte, powder-coated
Strut diameter x thickness:	16 x 2mm
Dimensions:	Length: 71 cm Width: 50 cm Height: 50 cm

Weight:

5,50 kg
