

80710824 OMNITRONIC HS-60 Druckkammerlautsprecher

- Schwenkbarer Lautsprecher
- 2-Wege Lautsprechersystem
- 6" Konuslautsprecher plus Tweeter für erweiterten Frequenzgang
- Hoher Schalldruck und breiter Übertragungsbereich
- Im wetterfesten Kunststoffgehäuse
- 100 V Trafo
- Für Beschallungsanlagen im Außenbereich wie z. B. Sportplätze, Schwimmbäder, Open Air-Veranstaltungen

Eingangsspannung: 100 V
 Lautsprecher: 6" + Tweeter
 Nennleistung Transformator: max. 50 W RMS
 Nennleistung Lautsprecher: 3,5/4,5/9//12,5/25/50 W RMS
 Empfindlichkeit: 99 dB, ±3 dB (1 W, 1 m)
 Max. Schalldruck: 108 dB (1 m)
 Impedanz: 8 Ohm
 Frequenzbereich: 90 Hz - 20 kHz
 Maße (H x B x T): 363 x 253 x 310 mm
 Gewicht: 3,9 kg

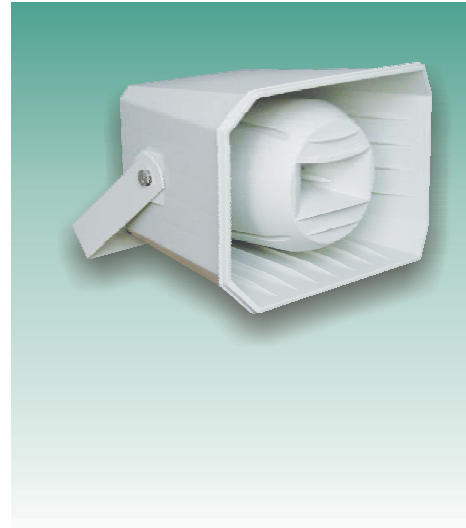

80710824 OMNITRONIC HS-60 pa horn speaker

- Swivable loudspeaker
- 2-way speaker-system
- 6" conical speaker and tweeter for extended frequency-range
- High sound pressure and wide frequency range
- In weather-proof plastic housing
- 100 V transformer
- For outdoor amplifying systems in football stadiums, outdoor pools, open air events

Input Voltage: 100 V
 Speakers: 6" + tweeter
 Rated power transformer: max. 50 W RMS
 Rated power speaker: 3.5/4.5/9//12.5/25/50 W RMS
 Sensitivity (1 W/m): 99 dB, ±3 dB
 Max. SPL (1 m): 108 dB
 Impedance: 8 Ohms
 Frequency range: 90 Hz - 20 kHz
 Dimensions (H x W x D): 363 x 253 x 310 mm
 Weight: 3.9 kg

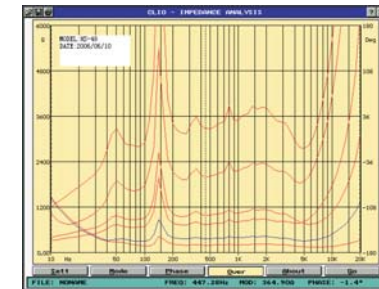
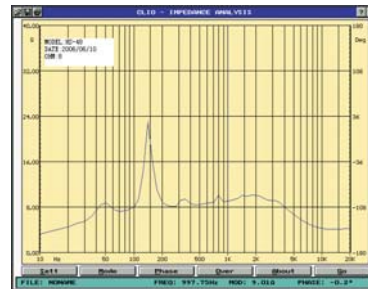
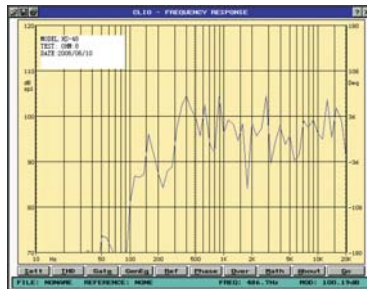
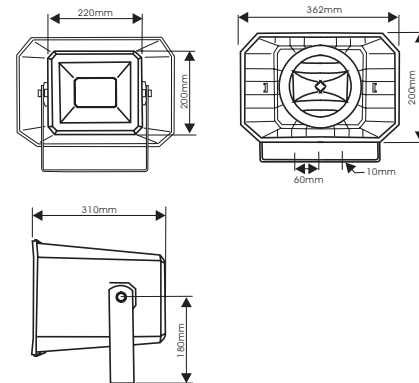

Horizontal:

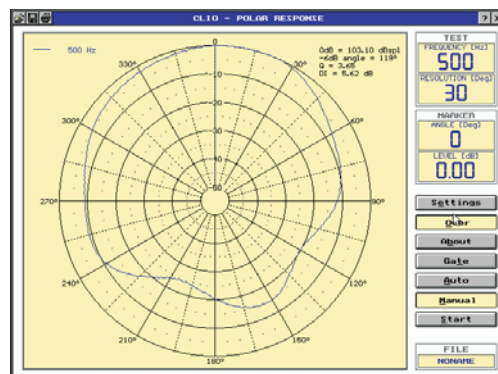

Vertical:

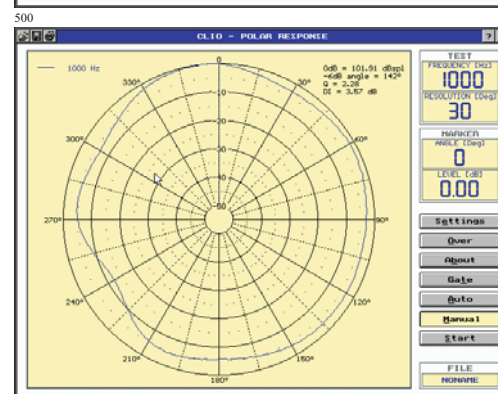
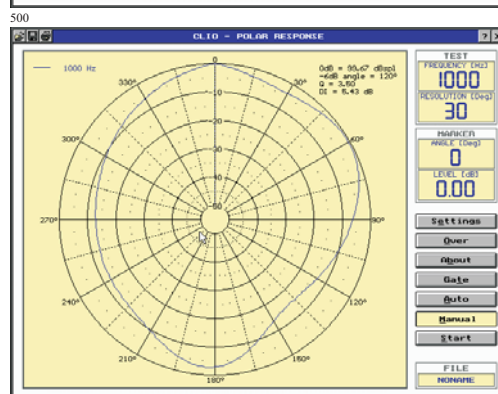
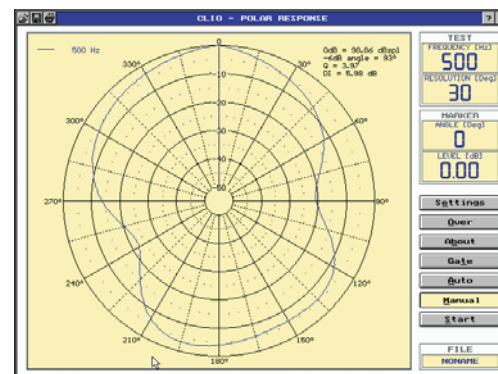

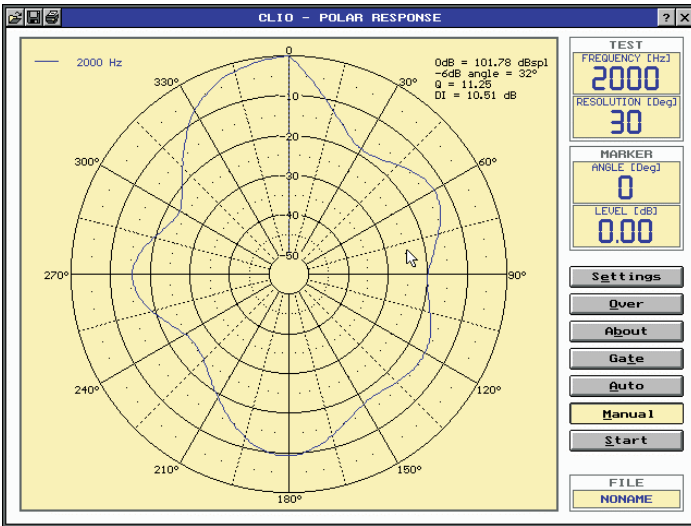

2000

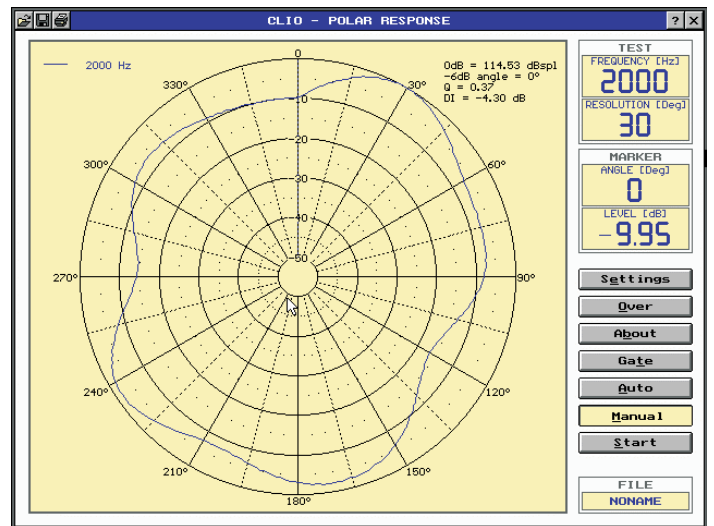

2000

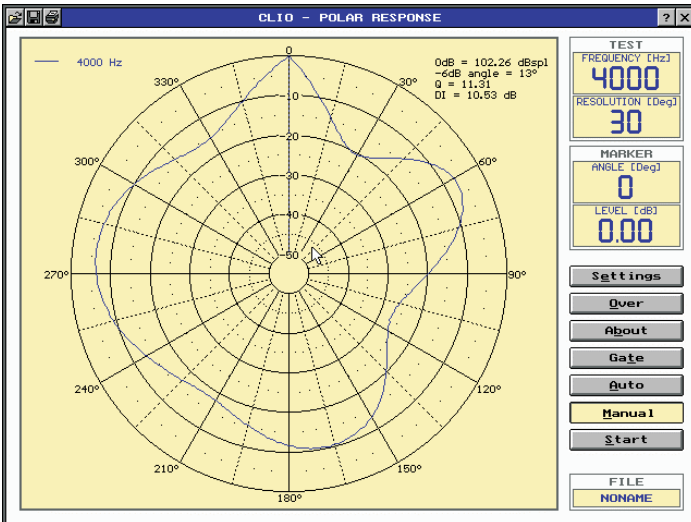

4000

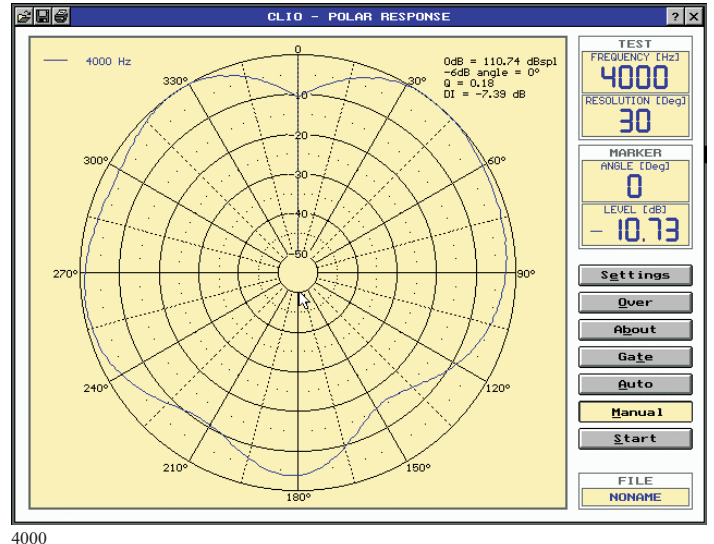

4000

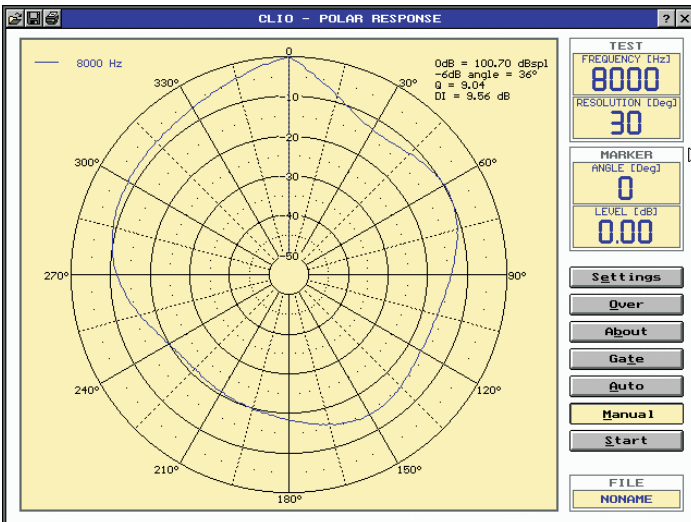

8000

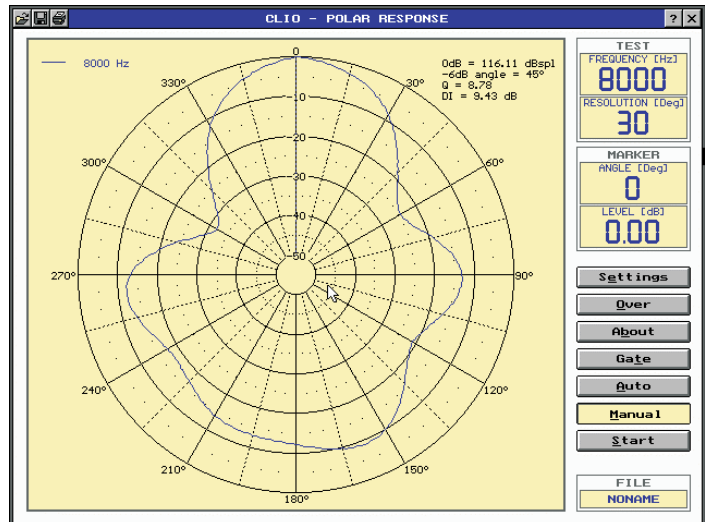

8000

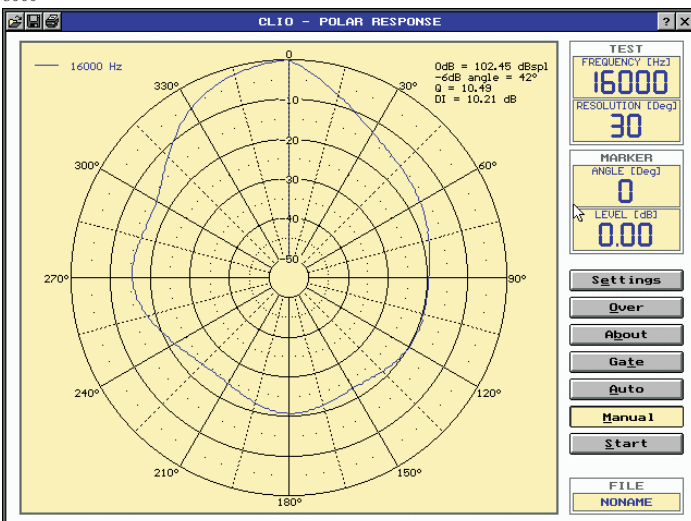

16000

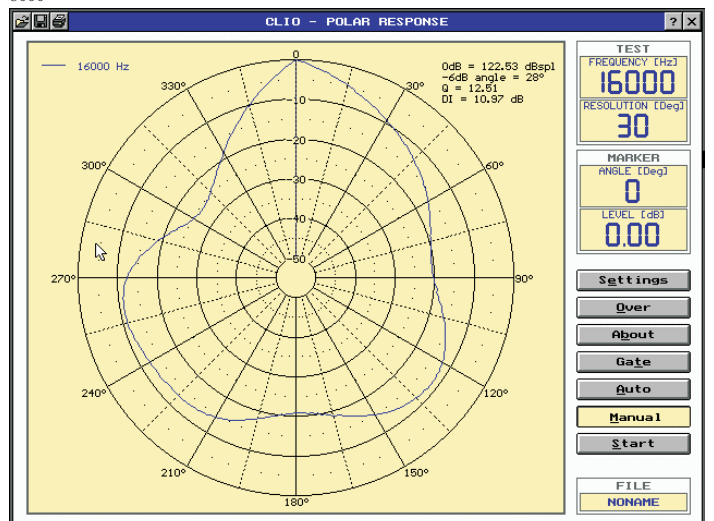

16000