

Verwendete Werkstoffe:

Legierung EN-AW 6082 T6
 Gurtrohre 50 x 3 mm
 Streben 25 x 3 mm
 Zubehör/Element 4x Verbindungskonus, 8x Zapfen, 8x Splint

Maximale Systemlänge: 16 Meter

Lasttabelle GL400:				
Spannweite (m)	Punktlast (kg)	Durchbiegung (mm)	Gleichlast (kg/m)	Durchbiegung (mm)
2	3267	1,4	2327	1,3
4	1803	6,4	901	8,0
6	1252	15,2	417	18,9
8	971	28,5	243	35,4
10	811	47,6	162	58,8
12	675	70,5	112	86,5
14	573	98,3	82	119,8
16	477	127,8	61	158,7

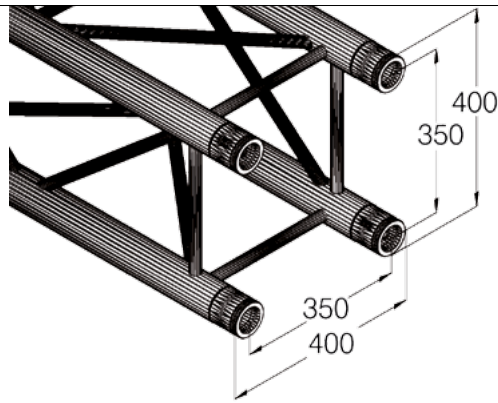

Quadlock GL400



- Best.-Nr. 6030629A..... GL400-500
- Best.-Nr. 6030629C..... GL400-1000
- Best.-Nr. 6030629E..... GL400-1500
- Best.-Nr. 6030629G..... GL400-2000
- Best.-Nr. 6030629J..... GL400-2500
- Best.-Nr. 6030629L..... GL400-3000
- Best.-Nr. 6030629N..... GL400-3500
- Best.-Nr. 6030629P..... GL400-4000
- Best.-Nr. 6030629R..... GL400-5000

ALUTRUSS QUADLOCK GL400-5000 4-Punkt-Traverse

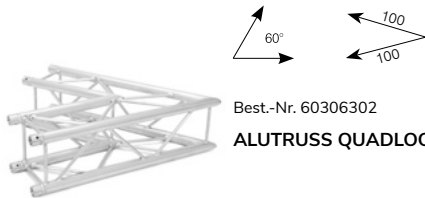

Best.-Nr. 60306302
ALUTRUSS QUADLOCK GL400-C20 2 Wege Ecke 60°

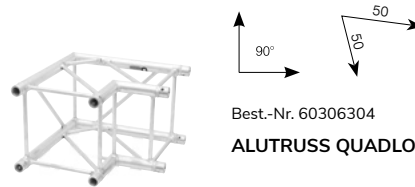

Best.-Nr. 60306304
ALUTRUSS QUADLOCK GL400-C21 2 Wege Ecke 90°

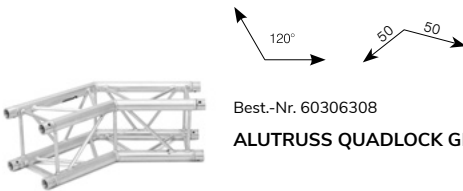

Best.-Nr. 60306308
ALUTRUSS QUADLOCK GL400-C23 2 Wege Ecke 135°

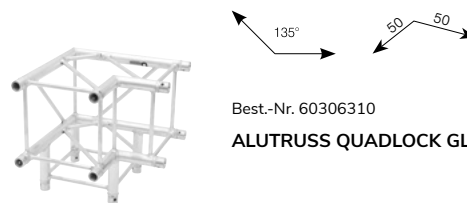

Best.-Nr. 60306310
ALUTRUSS QUADLOCK GL400-C30 3 Wege Ecke 90°

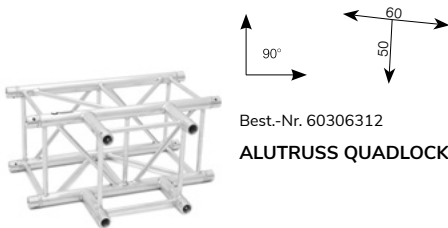

Best.-Nr. 60306312
ALUTRUSS QUADLOCK GL400-T35 3 Wege T-Stück

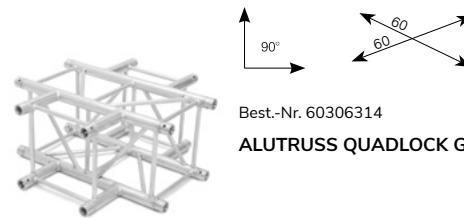

Best.-Nr. 60306314
ALUTRUSS QUADLOCK GL400-C41 4 Wege Kreuzung

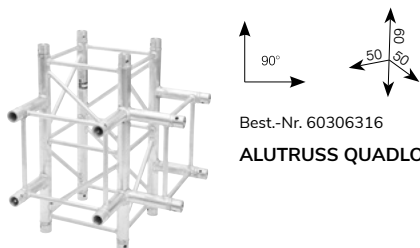

Best.-Nr. 60306316
ALUTRUSS QUADLOCK GL400-T42 4 Wege Kreuzung

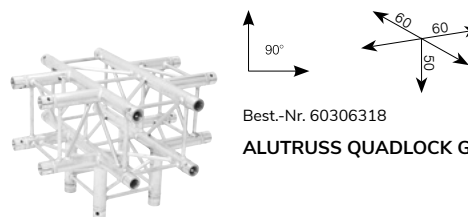

Best.-Nr. 60306318
ALUTRUSS QUADLOCK GL400-T51 5 Wege Kreuzung