

Verwendete Werkstoffe:

Legierung EN-AW 6082 T6 (AlSi1MgMn)
 Gurtrohre 50 x 2 mm
 Streben 16 x 2 mm
 Zubehör/Element 3 x Verbindungskonus, 6x Zapfen, 6x Splint
 Artikelnummer 60301895

Lasttabelle TRILOCK 6082:				
Spannweite (m)	Punktlast (kg)	Durchbiegung (mm)	Gleichlast	Durchbiegung
(m)	(kg)	(mm)	(kg/m)	(mm)
2	718	2,2	718	2,8
4	359	8,9	179	11,1
6	240	20,0	80	25,0
8	179	35,6	45	44,5
10	144	55,6	29	69,5
12	119	80,1	20	100,1
14	103	109,0	14	136,3
16	90	142,4	11	178,0

Maximale Systemlänge: 16 Meter

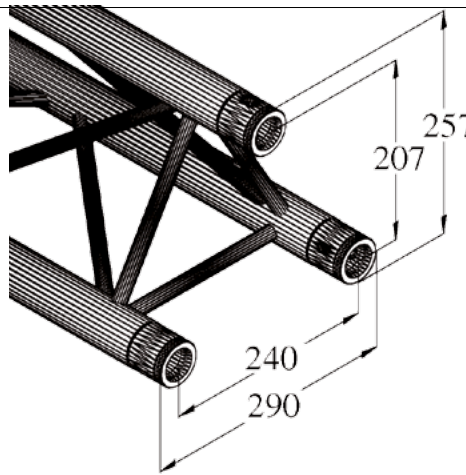

Trilock 6082

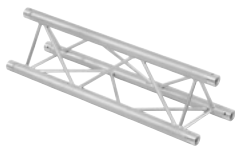

- Best.-Nr. 60302350 6082-210
- Best.-Nr. 60302353 6082-290
- Best.-Nr. 60302355 6082-500
- Best.-Nr. 60302357 6082-710
- Best.-Nr. 60302358 6082-1000
- Best.-Nr. 60302359 6082-1500
- Best.-Nr. 60302360 6082-2000
- Best.-Nr. 60302362 6082-2500
- Best.-Nr. 60302364 6082-3000
- Best.-Nr. 60302365 6082-3500
- Best.-Nr. 60302366 6082-4000
- Best.-Nr. 60302367 6082-4500
- Best.-Nr. 60302368 6082-5000

ALUTRUSS TRILOCK 6082 3-Punkt-Traverse

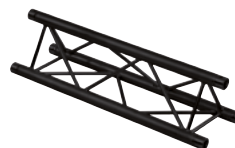

- Best.-Nr. 60302530 6082 S-210
- Best.-Nr. 60302531 6082 S-290
- Best.-Nr. 60302532 6082 S-500
- Best.-Nr. 60302534 6082 S-1000
- Best.-Nr. 60302535 6082 S-2000
- Best.-Nr. 60302536 6082 S-2500
- Best.-Nr. 60302537 6082 S-3000
- Best.-Nr. 60302538 6082 S-4000
- Best.-Nr. 60302539 6082 S-5000

ALUTRUSS TRILOCK 6082 3-Punkt-Traverse schwarz



- Best.-Nr. 60302380silber
- Best.-Nr. 6030253Fschwarz

ALUTRUSS TRILOCK 6082AC-19 2-Weg-Ecke 45°

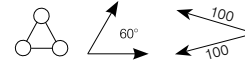

- Best.-Nr. 60302383silber
- Best.-Nr. 6030253Gschwarz

ALUTRUSS TRILOCK 6082AC-20 2-Weg-Ecke 60°

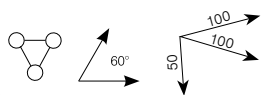

- Best.-Nr. 60302384
- ALUTRUSS TRILOCK 6082AC-20-3 3-Weg-Ecke 60°

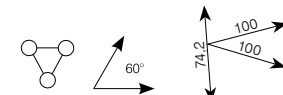

- Best.-Nr. 60302385
- ALUTRUSS TRILOCK 6082AC-20-4 4-Weg-Ecke 60°

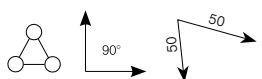

- Best.-Nr. 60302386silber
- Best.-Nr. 6030253Hschwarz

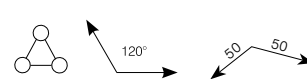

- Best.-Nr. 60302388silber
- Best.-Nr. 6030253Jschwarz

ALUTRUSS TRILOCK 6082AC-22 2-Weg-Ecke 120°