

**Materials used:**

Alloy EN-AW 6082 T6 (AlSi1MgMn)  
 Main chords 50 x 2 mm  
 Braces 16 x 2 mm  
 Accessory/truss 3 x connecting cone, 6x pivot, 6x pin  
 Item No. 60301895

Load table TRILOCK 6082:				
Span (m)	Point load (kg)	Deflection (mm)	UDL (kg/m)	Deflection (mm)
2	718	2,2	718	2,8
4	359	8,9	179	11,1
6	240	20,0	80	25,0
8	179	35,6	45	44,5
10	144	55,6	29	69,5
12	119	80,1	20	100,1
14	103	109,0	14	136,3
16	90	142,4	11	178,0

Maximum system length: 16 meters

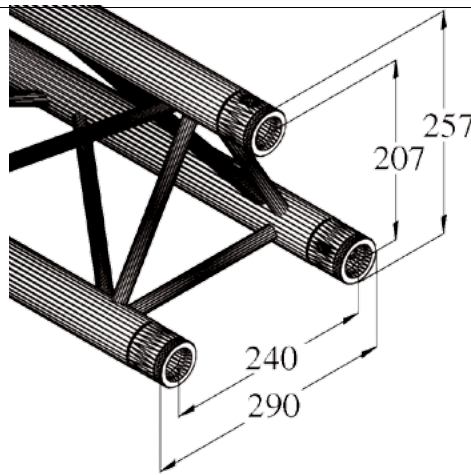

# Trilock 6082

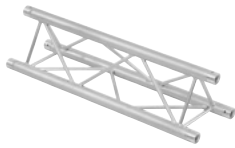

- No. 60302350.....6082-210
- No. 60302353.....6082-290
- No. 60302355.....6082-500
- No. 60302357.....6082-710
- No. 60302358.....6082-1000
- No. 60302359.....6082-1500
- No. 60302360.....6082-2000
- No. 60302362.....6082-2500
- No. 60302364.....6082-3000
- No. 60302365.....6082-3500
- No. 60302366.....6082-4000
- No. 60302367.....6082-4500
- No. 60302368.....6082-5000

ALUTRUSS TRILOCK 6082 3-Way Cross Beam

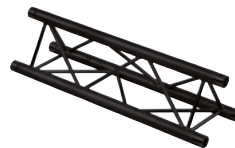

- No. 60302530.....6082 S-210
- No. 60302531.....6082 S-290
- No. 60302532.....6082 S-500
- No. 60302534.....6082 S-1000
- No. 60302535.....6082 S-2000
- No. 60302536.....6082 S-2500
- No. 60302537.....6082 S-3000
- No. 60302538.....6082 S-4000
- No. 60302539.....6082 S-5000

ALUTRUSS TRILOCK 6082 3-Way Cross Beam black

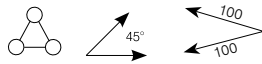

- No. 60302380.....silver
- No. 6030253F.....black

ALUTRUSS TRILOCK 6082AC-19 2-Way Corner 45°

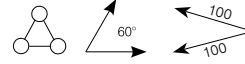

- No. 60302383.....silver
- No. 6030253G.....black

ALUTRUSS TRILOCK 6082AC-20 2-Way Corner 60°

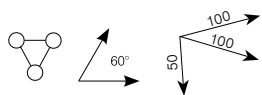

- No. 60302384
- ALUTRUSS TRILOCK 6082AC-20-3 3-Way Corner 60°

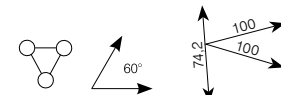

- No. 60302385
- ALUTRUSS TRILOCK 6082AC-20-4 4-Way Corner 60°

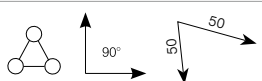

- No. 60302386.....silver
- No. 6030253H.....black

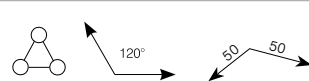

- No. 60302388.....silver
- No. 6030253H.....black

ALUTRUSS TRILOCK 6082AC-22 2-Way Corner 120°