

Verwendete Werkstoffe:

Legierung EN-AW 6060 T66 (AlMgSi0,5)
 Gurtrohre 35 x 2 mm
 Streben 10 x 2 mm
 Zubehör/Element 4 x Verbindungskonus, 8x Zapfen, 8x Splint
 Artikelnummer 60301790

Maximale Systemlänge: 16 Meter

Lasttabelle DQ4:				
Spannweite (m)	Punktlast (kg)	Durchbiegung (mm)	Gleichlast (kg/m)	Durchbiegung (mm)
2	472	1,8	472	2,3
4	236	7,2	118	9,0
6	157	16,2	52	20,3
8	118	28,8	30	36,1
10	95	45,1	19	56,3
12	78	64,9	13	81,1
14	67	88,3	9	110,4
16	59	115,4	7	144,2



- Best.-Nr. 60301707 DQ4-200
- Best.-Nr. 60301708 DQ4-250
- Best.-Nr. 60301710 DQ4-500
- Best.-Nr. 60301711 DQ4-750
- Best.-Nr. 60301712 DQ4-1000
- Best.-Nr. 60301714 DQ4-1500
- Best.-Nr. 60301716 DQ4-2000
- Best.-Nr. 60301718 DQ4-2500
- Best.-Nr. 60301720 DQ4-3000
- Best.-Nr. 60301724 DQ4-4000

ALUTRUSS DECOLOCK DQ4-200 4-Punkt-Traversal

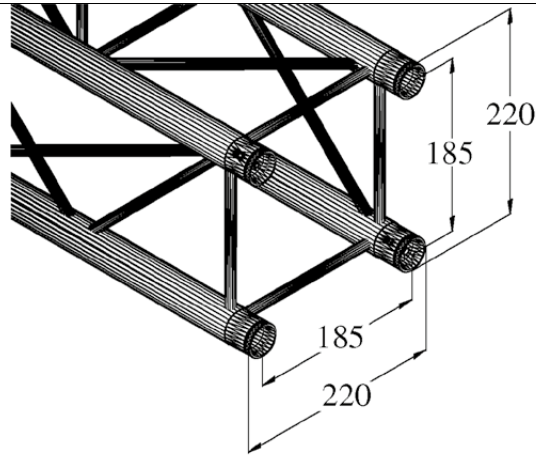

including connecting cone

Decolock DQ4

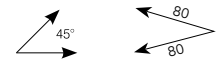

Best.-Nr. 60301730
ALUTRUSS DECOLOCK DQ4-PAC19 2-Weg Ecke 45°

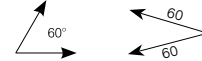

Best.-Nr. 60301732
ALUTRUSS DECOLOCK DQ4-PAC20 2-Weg Ecke 60°



Best.-Nr. 60301734
ALUTRUSS DECOLOCK DQ4-PAC21 2-Weg Ecke 90°

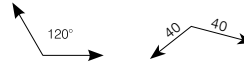

Best.-Nr. 60301736
ALUTRUSS DECOLOCK DQ4-PAC22 2-Weg Ecke 120°



Best.-Nr. 60301738
ALUTRUSS DECOLOCK DQ4-PAC23 2-Weg Ecke 135°

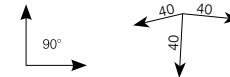
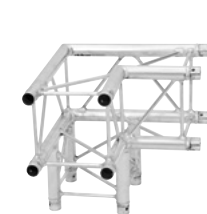

Best.-Nr. 60301744
ALUTRUSS DECOLOCK DQ4-PAL30 3-Weg Ecke 90°

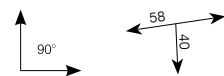

Best.-Nr. 60301752
ALUTRUSS DECOLOCK DQ4-PAT35 3-Weg T-Stück 90°



Best.-Nr. 60301758
ALUTRUSS DECOLOCK DQ4-PAC41 4-Weg Kreuz