

1 500

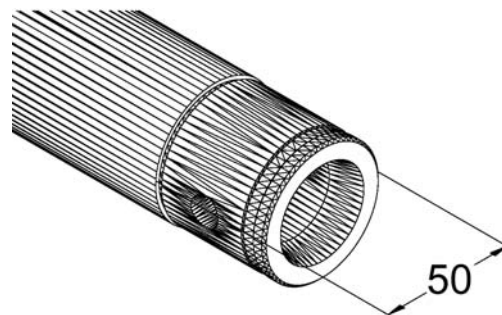
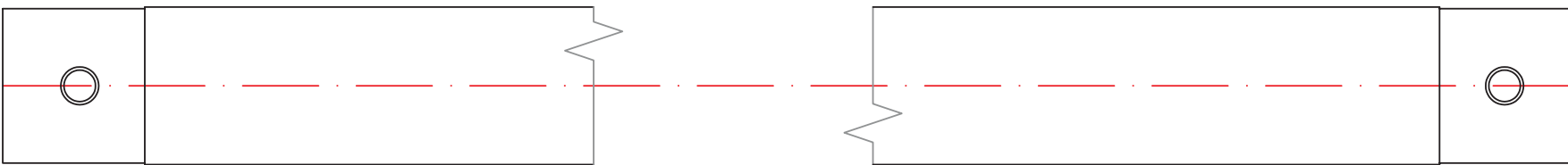
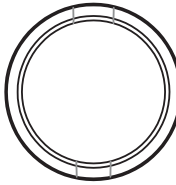
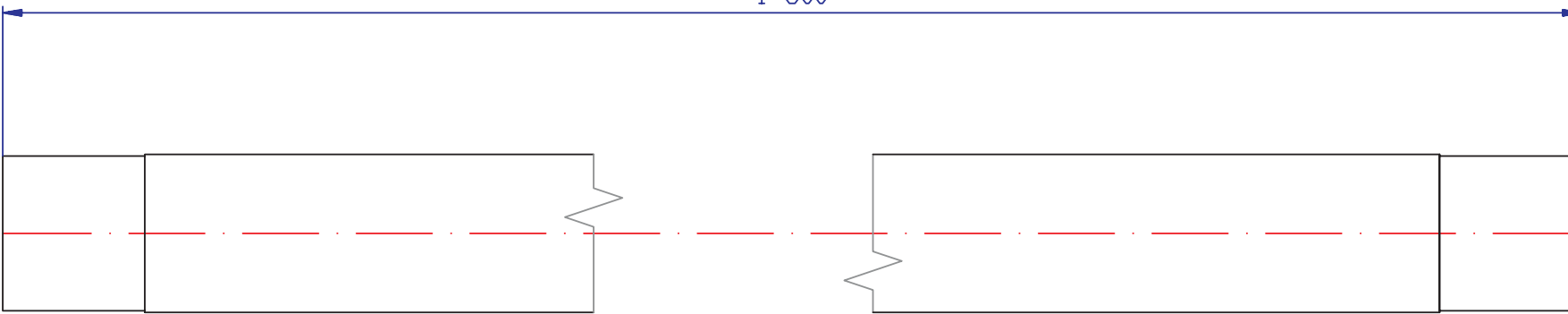

alutrus	
SINGLELOCK SP-1500	
Engineering Drawing	
Date: 19.07.2006	Sheet: 1/1