

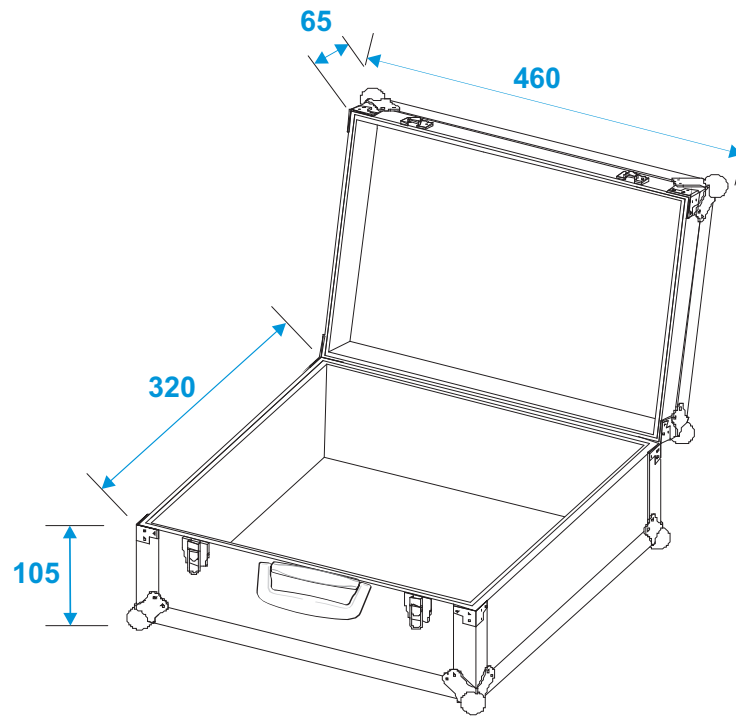

Flightcase

30126207 Universal case FOAM,



*all dimensions in millimeters

