

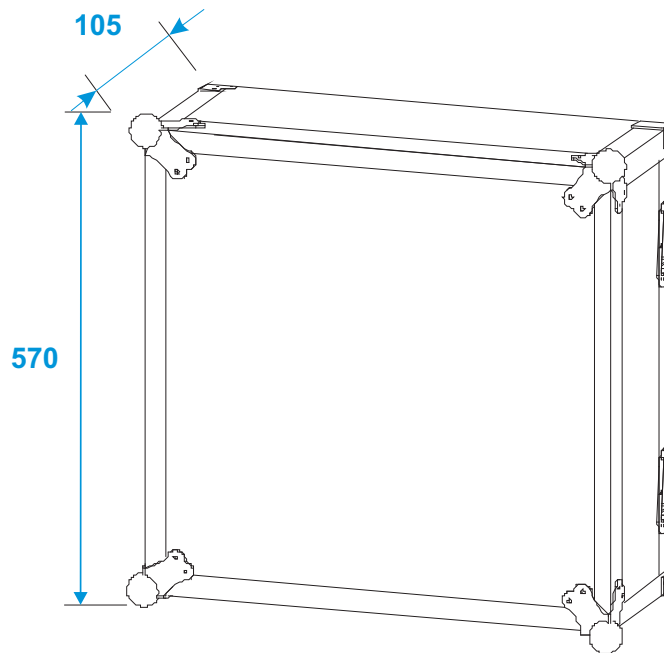

# Flightcase

**30109716** AMPLIFIER RACK SP-2 10U

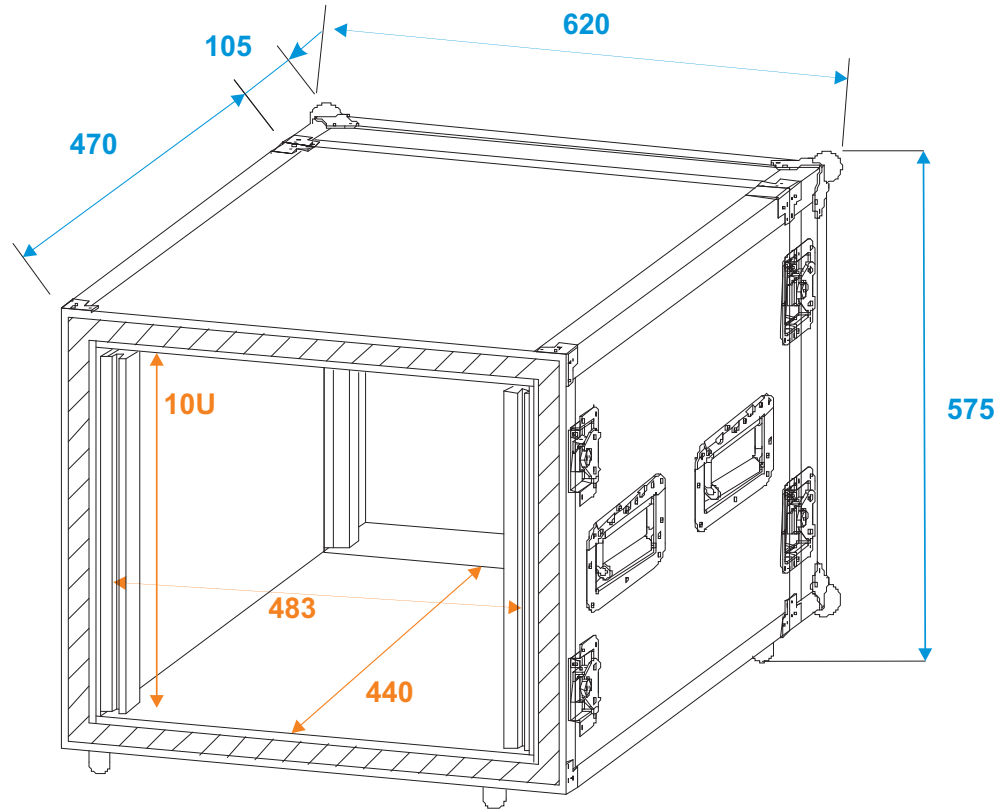

\*all dimensions in millimeters