

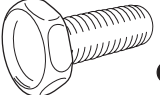





FLYING HARDWARE FOR PAS-215II

V-2

ENGLISH

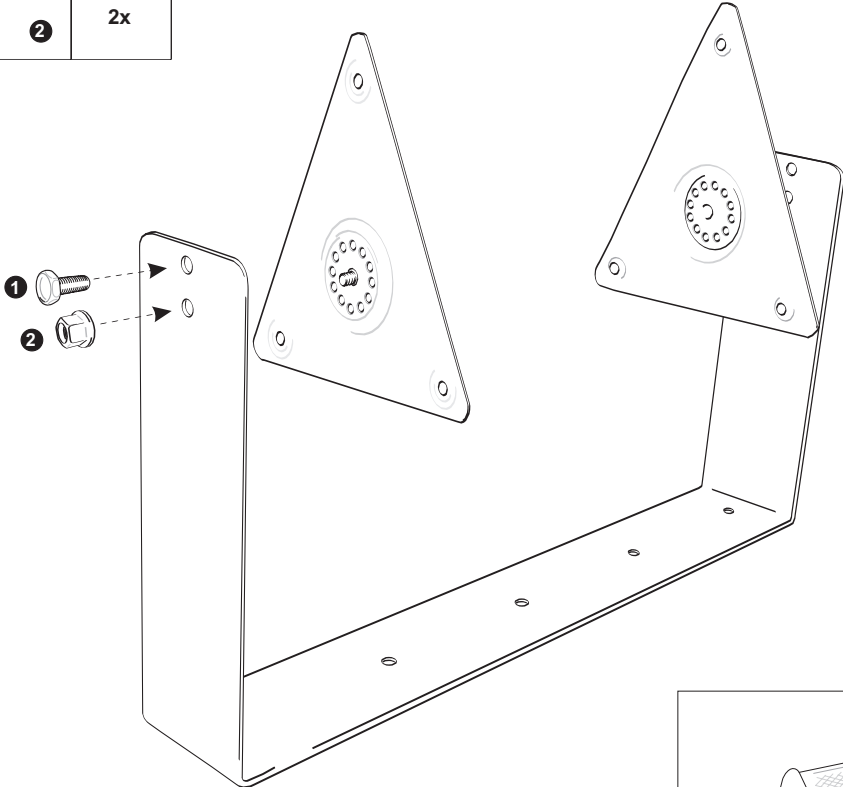
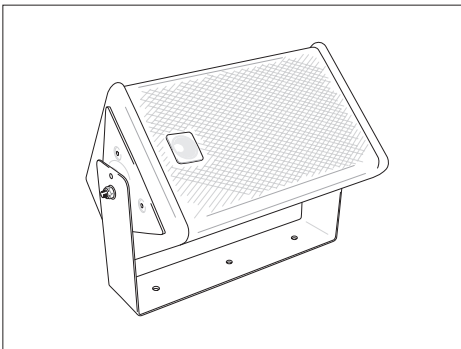
 1	2x
 2	2x

 Installation only by authorized personnel.
 Follow the safety instructions in the user manual.

TECHNICAL SPECIFICATIONS

Material:steel, black painted
 Maximum load:30 kg
 Weight:7 kg



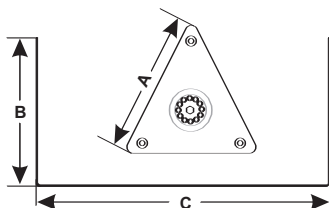

	A	B	C
Dimensions	335 mm	345 mm	720 mm



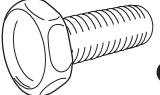

MONTAGEHALTERUNG FÜR PAS-215II

V-2

DEUTSCH

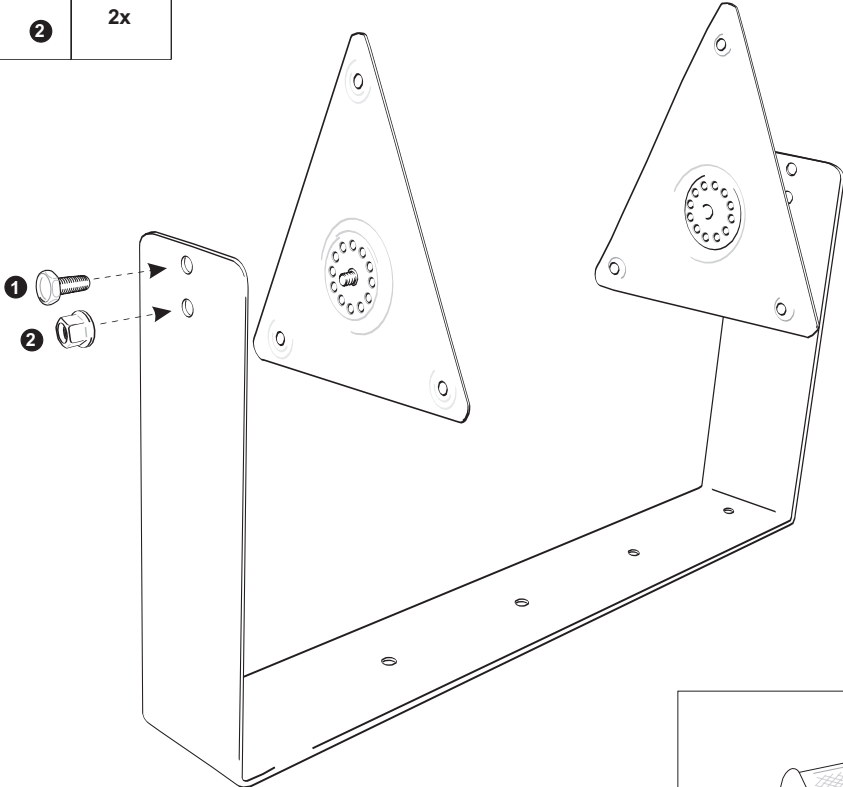
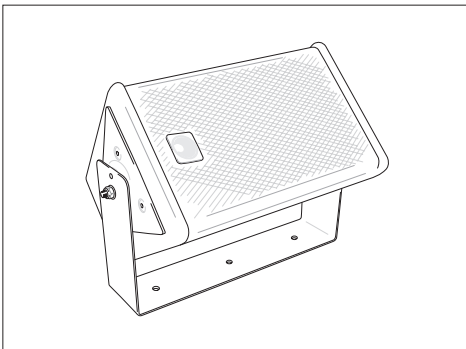
	1	2x
	2	2x

 Installation nur durch Fachpersonal.
 Beachten Sie die Sicherheitshinweise in der Bedienungsanleitung.

TECHNISCHE DATEN

Material:.....Stahl, schwarz lackiert
 Maximale Last:.....30 kg
 Gewicht:.....7 kg

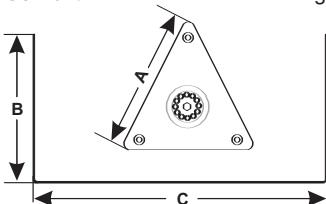

	A	B	C
Maße	335 mm	345 mm	720 mm